

Optimization and improved Bandwidth of Fork shape Microstrip Antenna via Artificial Neural Network

Pritam Singha Roy¹ and Shamik Chakraborty²

¹(Electronics Department, Govt. College of Engg & Textile Technology, Berhampore, India)

²(Electronics & Comm. Department, Indian Maritime University, Kolkata, India)

Abstract: A compact Fork- shaped Microstrip patch antenna with improved bandwidth is presented in this paper. The proposed antenna is design and analysis with dielectric substrate of RT/Duroid 2.2 and substrate thickness 3.17 mm. Antenna resonates at multi band of 7.46 GHz and 4.46 GHz. The proposed antenna is optimized with ANN model. The comparison between measured, simulated and ANN results for slotted microstrip patch antenna has been discussed. The proposed antenna has been fabricated and tested in laboratory. The measured and simulated results are exhibits good agreement. The proposed antenna achieved 40.34% of bandwidth at centre frequency of 7.46 GHz with $VSWR \leq 2$ and gain is 4.09dBi.

Keywords: Bandwidth ; Gain; Fork-slot; Microstrip antenna; Return loss; ANN.

I. Introduction

The microstrip patch antenna is most preferred antenna because of its light weight, low profile, easy fabrication and low cost. Generally microstrip antenna has narrow bandwidth, which limits their applications in modern communication system. Now the multiband antenna has the great advantage in communication system. In this paper introduced a multiband microstrip patch antenna with improved bandwidth. The most common technique to design a microstrip antenna DGS and slot on the patch [1]. Most microstrip-fed structures of the printed slot antenna have been used by using the microstrip-fed structures [2] across the center of slot [3]. In present work Fork shape patch antenna is proposed with improved bandwidth and reduced size of antenna for multi band applications. The antenna structure is optimized by adjusting the dimension of antenna using Artificial Neural network. Artificial Neural Network are developed for characterizing the Fork shaped patch antenna with multi band frequencies. ANN models is more accurate than other nonlinear models and provides more advantages [4-6]. Here the trained ANN data is used to find the different antenna characteristics by varying the structural input parameters of proposed antenna. The novelty of the work described here is that optimized the important characteristics, namely, resonant frequency, return loss, bandwidth and gain. In proposed work the multilayer back propagation is used to optimize the antenna structure as well as the antenna characteristics.

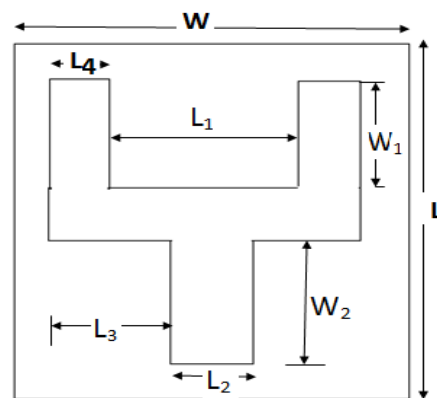

Figure (a)

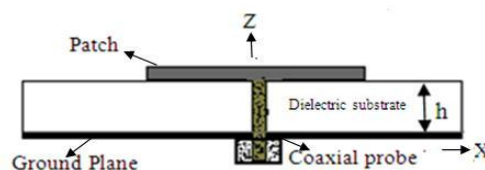

Figure (b)

Figure.1 Geometry of proposed Fork-shape Microstrip antenna (a) Top view; (b) Cross section view

II. geometrical study of proposed antenna

The structure of proposed antenna is shown in Fig. 1, where a coaxial fed is used over a RT/Doroid substrate of thickness of $h=3.17$ mm and permittivity $\epsilon_r = 2.2$.

The patch has the dimension of $26 \text{ mm} \times 46 \text{ mm}$. Three rectangular slots are cut from the patch and obtained a Fork- shaped slotted microstrip patch.

For a given resonance frequency (f) and dielectric substrate (ϵ_r) the parameters of proposed antenna are expressed [8-10] as follows:

$$W = \frac{c}{2f\sqrt{\frac{\epsilon_r + 1}{2}}} \quad (1)$$

$$L = L_{eff} - 2\Delta L \quad (2)$$

Where e_{ff} and ΔL are the effective and extended length of patch and expressed as:

$$L_{eff} = \frac{c}{2f_o\sqrt{\epsilon_{reff}}} \quad (3)$$

$$(\Delta L) = 0.412h \frac{(\epsilon_{reff} + 0.3) \left(\frac{W}{h} + 0.264\right)}{(\epsilon_{reff} - 0.258) \left(\frac{W}{h} + 0.8\right)} \quad (4)$$

ϵ_r is the effective dielectric constant of substrate is expressed as:

$$\epsilon_{reff} = \frac{\epsilon_r + 1}{2} + \frac{\epsilon_r - 1}{2} \left[1 + 12 \frac{h}{W}\right]^{-\frac{1}{2}} \quad (5)$$

Hence for this design the ground plane length (L_g) and width (W_g) would be given as:

$$L_g = 6h + L \quad (6)$$

$$W_g = 6h + W \quad (7)$$

Where “h” is the thickness of substrate (in mm).

Table1. Optimal parameters specification of antenna

Parameter	W	L	W ₁	W ₂	L ₁	L ₂	L ₃	L ₄
Values(mm)	46	26	16	18	14	10	8	6

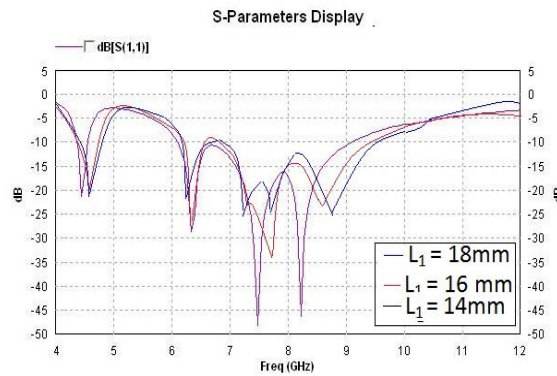

Figure (a)

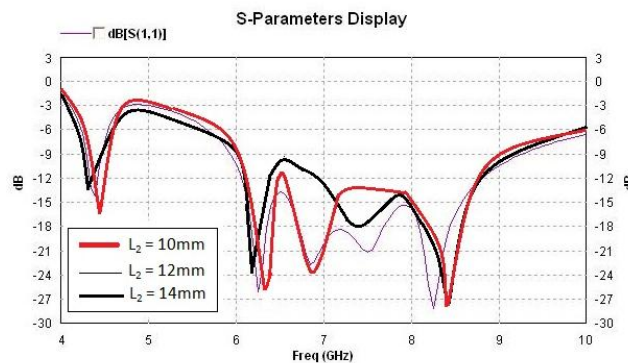

Figure (b)

Figure.2 Simulated Return loss (S_{11}) (a) Variation of L_1 , while all other parameters in Table 2 are fixed; (b) Variation of L_2 , while all other parameters in Table 3 are fixed.

Table 2. Parameters for different values of L_1
($L_2=10$ mm, $W_1=16$ mm, $W_2=18$ mm, Feed point=10, 19)

L_1 mm	Frequency Ghz	Return Loss	Gain dBi	BW Ghz	Vswr
14	7.46	-46.14	4.06	40.34%	1.02
16	7.69	-32.58	4.51	35.12%	1.10
18	7.79	-24.11	6.52	34.87%	1.13

Table 3. Parameters for different values of L_2
($L_1=14$ mm, $W_1=16$ mm, $W_2=18$ mm, Feed point=10,19)

L_2 mm	Frequency Ghz	Return Loss	Gain dBi	BW Ghz	Vswr
10	8.26	-27.11	4.88	36.28%	1.23
12	8.25	-28.09	4.62	37.04%	1.68
14	8.23	-27.23	4.58	38.85%	1.87

III. parametric analysis of proposed antenna

In this antenna the resonance frequency and Return loss are affected by the following parameters as L_1 , L_2 , W_1 and W_2 . It is observed that the resonance frequency (f) and bandwidth are increased but return loss is decreased with increase the value of L_1 (Other parameters are constant) shown in Fig2(a) referred to the Table 2. On the other hand the resonance frequency is decreased with increased the value of L_2 and Bandwidth is increased slowly is shown in Fig 2(b).referred to the Table 3.

IV. Ann Implementation and results

The Levenberg-Marquardt to neural network training is discussed in this paper. The Levenberg-Marquardt Back Propagation (LMBP) algorithm has been shown to be the fastest method for training moderate sized feed-forward neural networks (a few hundred weights). It also useful for accurate training but some cases the LMBP is produces small amount of mean square errors than other ann algorithms tested. Since the solution of the matrix equation is a built-in function. In order to make sure that the approximated Hessian matrix \mathbf{H} and Jacobian matrix \mathbf{J} can be rewritten as $\mathbf{J}^T \mathbf{J}$ is invertible; Levenberg-Marquardt algorithm introduces another approximation to Hessian matrix:

$$\mathbf{H} \approx \mathbf{J}^T \mathbf{J} + \mu \mathbf{I} \quad (\text{a})$$

Where μ is always positive, called combination coefficient \mathbf{I} is the identity matrix.

The update rule of the Gauss-Newton algorithm is presented as

$$\mathbf{W}_{k+1} = \mathbf{W}_k - (\mathbf{J}_k^T \mathbf{J}_k)^{-1} \mathbf{J}_k \mathbf{e}_k \quad (\text{b})$$

By combining Equations (a) and (b), the update rule of Levenberg-Marquardt algorithm can be presented as

$$\mathbf{W}_{k+1} = \mathbf{W}_k - (\mathbf{J}_k^T \mathbf{J}_k + \mu \mathbf{I})^{-1} \mathbf{J}_k \mathbf{e}_k \quad (\text{c})$$

As the combination of the steepest descent algorithm and the Gauss-Newton algorithm, the Levenberg-Marquardt algorithm switches between the two algorithms during the training process. When the combination coefficient μ is very small (nearly zero), Equation (c) is approaching to Equation (b) and Gauss-Newton algorithm is used. When combination coefficient μ is very large, Equation (c) approximates to Equation (a) and the steepest descent method is used.

In this current problem the neural network architecture shown in Figure.3(a,b) which consists of four input nodes, four output nodes and two hidden layers (twenty five nodes each layer). Four input variables are feed point (f_p), width (W_1), length (L_1) and length (L_2). The weight W_{ji}^{11} represents between input layer i and first hidden layer j , W_{kj}^{21} represents weight between the first hidden layer j and 2nd hidden layer k and W_{ik}^{32} weight between k and i . The LMBP training graph shown in Figure 4. The performance is 0.0058398 which is reached at the end of 180 epochs. The model is trained with 880 sets of input/output data, which are obtained by IE3D and for test purpose used 20 data sets

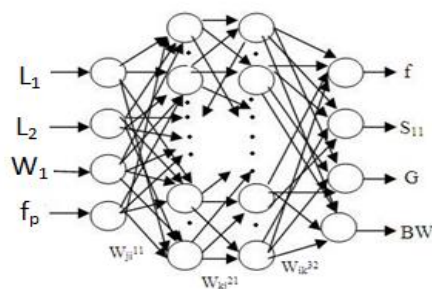

Figure.3 (a): ANN architecture for LMBP training

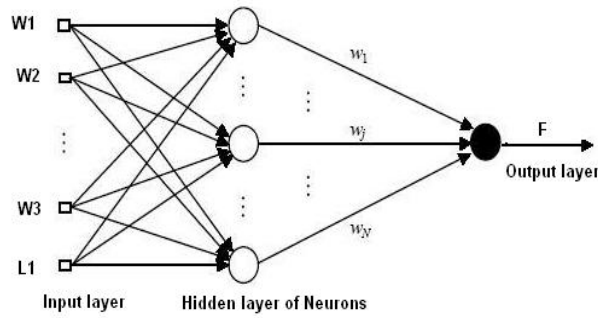

Figure 3(b). Three layer MLPFFBP network architecture

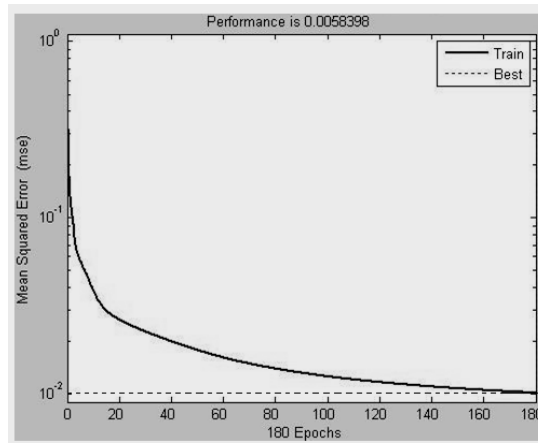

Figure.4: Performance between MSE and number of epochs

Table 4. Parameters for different techniques

Performance parameter	Res.Freq(GHz)	BW (%)	Gain(dBi)	Return loss(dB)
LMBP ANN	6.98	37.11	3.88	-44.02
Simulated by IE3D	7.46	40.34	4.06	-46.14
Measured	7.22	38.02	3.69	-40.31

The S-parameter display for different values of L_1 , L_2 , W_1 and f_p shown in Table 4. The simulated bandwidth of the proposed antenna is from 6.11 GHz to 9.12 GHz and which is approximately 40.34% at the center frequency 7.46 GHz. The return loss of simulated and measured both is much closed. The ANN trained bandwidth and return loss are closer to the simulated result.



Figure 4. Front view of fabricated proposed Fork slot antenna

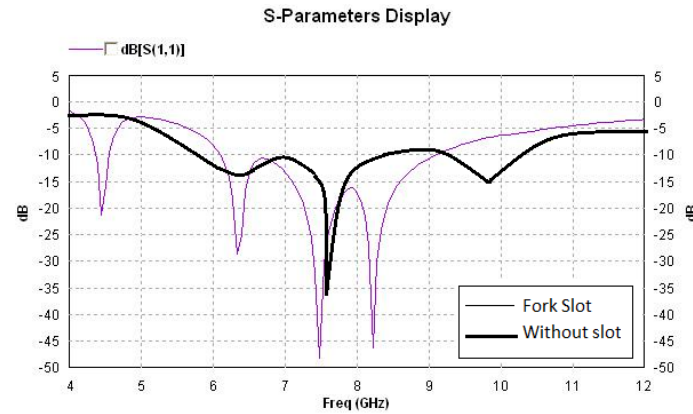

Fig 5. Simulated results (S₁₁) of proposed Fork-slot and without slot.

Table 5. Bandwidth of proposed antenna

Bandwidth	IE3D	Measured
Without slot	16% (8.12-7.0)	14.82% (8.21-7.11)
With Fork slot	40.34 % (9.12-6.11GHz)	38.02% (8.62-5.88)

The proposed antenna is tested and fabricated on dielectric PTFE 2.2 and found the measured results for fork slot and without slot results bandwidth referred to the Table 5. The Fork slotted antenna increased the bandwidth by 38.02% than without slotted rectangular microstrip antenna. The variation of Bandwidth for both slotted and without slotted microstrip antenna shown in fig 5. The antenna operating with VSWR is 1.02 shown in fig 7. The simulated current distributions of Fork –shaped microstrip patch antenna shown in Figure 7. From current current distribution characteristics of Figure 7, it is observed that current is equally distributed from the two similar end of proposed antenna.

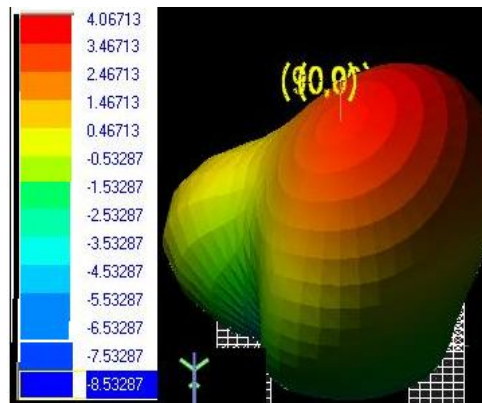

Figure 6. Radiation pattern of proposed antenna

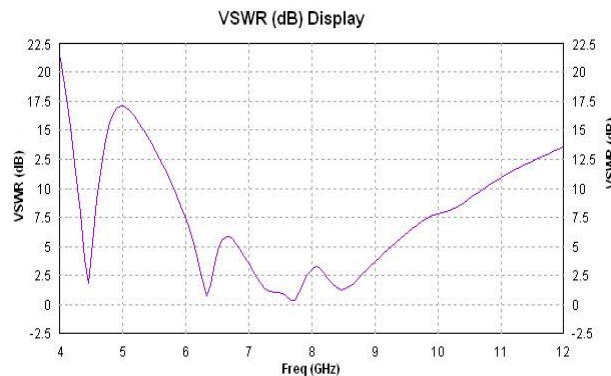

Fig 7. Measured VSWR results of proposed antenna

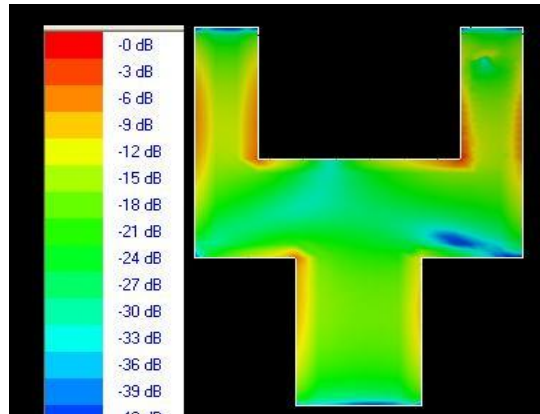

Fig 7. Current distribution pattern of proposed antenna

Fig 8 shows the impedance (49.67Ω) locus of the Fork- shaped microstrip patch antenna at resonance frequency of 7.46GHz.

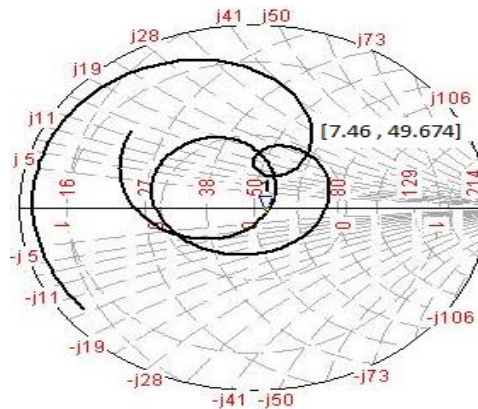

Fig 8 .Smith Chart Display for proposed antenna at 7.46GHz.

V. Conclusion

A new Fork shape antenna for achieve the bandwidth of a microstrip patch antenna has been developed successfully. Artificial Neural Network structure is used to optimize the parameters. The proposed microstrip patch antenna can be achieving improved bandwidth. This paper presents a novel structure of Fork shaped antenna with dual frequencies of operations .Artificial neural network with multilayer back propagation used to minimized the errors and optimized the antenna parameters and dimentions.Simulated and Levenberg-Marquardt Neural Network outputs are satisfactory for microstrip broad banding, antenna size reduction, stable radiation pattern. The antenna has improved good performance in terms of VSWR, current distribution, gain, return loss.

References

- [1] T.K.Lo and Y.Hwng, "Microstrip antennas of very high permittivity using iris,"*Electron Lett.*, vol.40 no. 12, pp.718-719,Jun .2004
- [2] R.A. Sainati CAD of micro strip antenna for wireless applications. Artech House, Inc 1996
- [3] I.S. Jacobs and C.P. Bean, "Fine particles, thin films and exchange anisotropy," in *Magnetism*, vol. III, G.T. Rado and H. Suhl, Eds. New York: Academic, 1963, pp. 271-350.
- [4] Haykin, S., "Neural Networks:A Comprehensive Foundation". Printice-Hall Inc., USA, 1999.
- [5] Christodoulou, C. G.; Georgiopoulos, M., "Applications of Neural Networks in Electromagnetics". Artech House, USA,2001.
- [6] Krose , Ben;van der Smagt,P., "An Introduction to Neural Networks". University of Amsterdam, Netherlands,November 1996.
- [7] M. Young, *The Technical Writer's Handbook*. Mill Valley, CA: University Science, 1989.